

# Data Sheet



Article number: 2307083603

Description: E+G Direct drive position indikator  
DD52R-FR-000.50-D-C2 (Orange)

## Measures

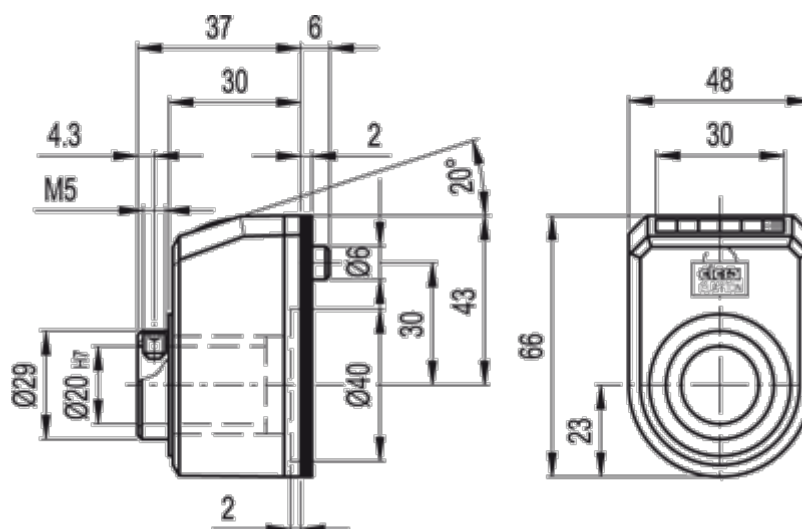

Max rpm = 500